

Captrad Cable Systems

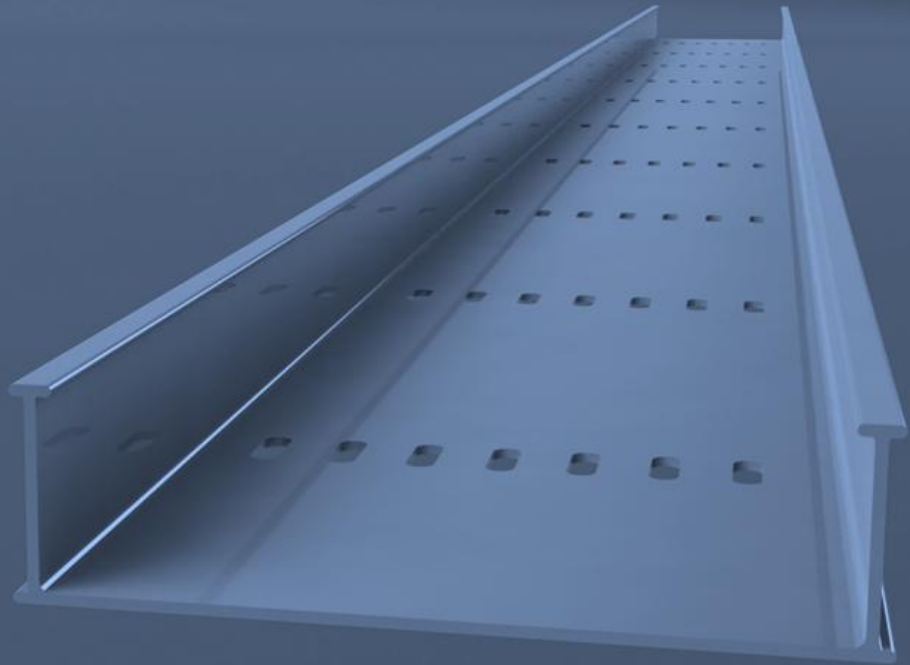

grp cable systems



Captrad Ltd

Was established in 1999 based in Wigan in the North of England. Originally Captrad Ltd supplied Industrial Chemicals into various industries across the UK., and as time passed we were always looking for new business opportunities and thus this is how we have ended up supplying a wide range of Composite Products across the world.

As a result Captrad Ltd has tried to bring the whole composite solution under one umbrella. Thus we now have customers from a variety of industries from: Rail, Offshore, Constructions, Civils and Water, all being able to purchase quality products from one place ensuring continuity of service.

We have been able to set up a network of satellite offices around the world to help improve and maintain customer service levels.

GRP Cable Systems

Captrad Cable Trays have been design and manufactured with the user in mind, whilst offering excellent performance ease of use. Our Cable Trays can be supplied in a variety of sizes along with a comprehensive array of fittings to cater for any project large or small. Captrad Cable Trays can be supplied either as the tray or with the uniquely designed 'Click-fit-Lid'. All our trays are produced in 3mtr lengths and can easily be fabricated on/off site.

Advantages

Corrosion Resistant	Impact Resistant
Strong & Lightweight	Click Fit Lid System
Non-Conductive	Easy to fabricate
Dimension Stability	UV Stability
Excellent Working Temperatures	

Markets

Alternative Energy	Industrial
Rail/Underground	Off Shore
Marine	Construction
Chemical Plant	Water Industry



GRP Cable Trays

GRP Cable Trays at a glance		
	Standard	Alternative
Material	ISO Polyester Resin	
Fire Rating	Class 2 Fire Rated	Modar
Length	3000mm	6000
Width	50-300mm	
Type	Slotted	Plain
Fittings	All Stainless Steel	

Specifications

The cable trays are manufactured glass by the pultrusion process from isophthalic polyester thermosetting resin reinforced with E glass giving a high strength dimensionally accurate and thermally stable product. The pultruded sections fully comply with all the requirements of EN13706, grade E17 – Specification of pultruded profiles.

The standard polyester resin is a halogen free fire retardant grade satisfying the requirements of BS476 Pt7, Class 2 and ASTM E84 25 sec - Surface spread of flame. Higher grade fire retardant products can be manufactured to order including the high fire resistance, low smoke and low toxicity required by the London Underground (LUL). Cable Trays can also be made to order in the highly corrosion resistant vinyl ester resin.

GRP cable trays are normally electrical non-conductive but for those applications with risk explosive atmospheres an anti-static version is available to order.

The cable tray is slotted along the length the cable tray also has a unique accepting slot that allows couplers to be inserted with ease insitu. All cable trays have a bespoke click fit lid.

Cable Tray (without cover) distributed load in Kg over the span

SPAN (M)	1	1.5	2	2.5	3
DEFLECTION (MM)	5	7.5	10	12.5	15
Tray	UDL in Kg at this span for deflection limited to span /200				
100x50	231	103	58	37	26
150x50	247	110	62	39	27
200x50	271	121	68	43	30
300x50	294	131	74	47	33

GRP Cable Trays – Product Codes

Product	Width	Height	Kg/mtr
GRPCT50100/3	100mm	50mm	1.34
GRPCT50150/3	150mm	50mm	1.67
GRPCT50200/3	200mm	50mm	1.96
GRPCT50300/3	300mm	50mm	2.55
GRPCT80100/3	100mm	80mm	1.73
GRPCT80150/3	150mm	80mm	2.02
GRPCT80200/3	200mm	80mm	2.31
GRPCT80300/3	300mm	80mm	2.90

Product	Width	Products	Kg/each
GRPCTLD100/3	100mm	Fits 50/80	0.91
GRPCTLD150/3	150mm	Fits 50/80	1.22
GRPCTLD200/3	200mm	Fits 50/80	1.53
GRPCTLD100/3	100mm	Fits 50/80	0.91

Product	Width	Height	Kg/each
GRPFB90-50100	100mm	50mm	0.70
GRPFB90-50150	150mm	50mm	0.85
GRPFB90-50200	200mm	50mm	1.15
GRPFB90-50300	300mm	50mm	1.75
GRPFB90-80100	100mm	80mm	0.90
GRPFB90-80150	150mm	80mm	1.10
GRPFB90-80200	200mm	80mm	1.35
GRPFB90-80300	300mm	80mm	1.95

Product	Width	Height	Kg/each
GRPFB45-50100	100mm	50mm	0.70
GRPFB45-50150	150mm	50mm	0.85
GRPFB45-50200	200mm	50mm	1.15
GRPFB45-50300	300mm	50mm	1.75
GRPFB45-80100	100mm	80mm	0.90
GRPFB45-80150	150mm	80mm	1.10
GRPFB45-80200	200mm	80mm	1.35
GRPFB45-80300	300mm	80mm	1.95

Tray & Lid

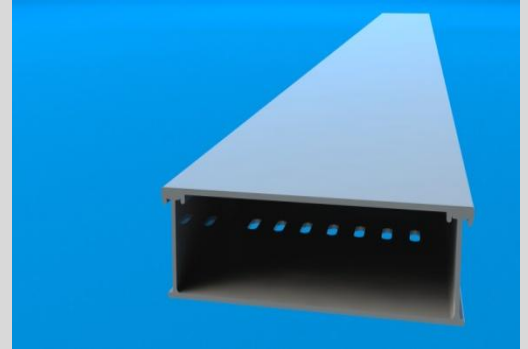

Bends

Cable Tray 90° Bend

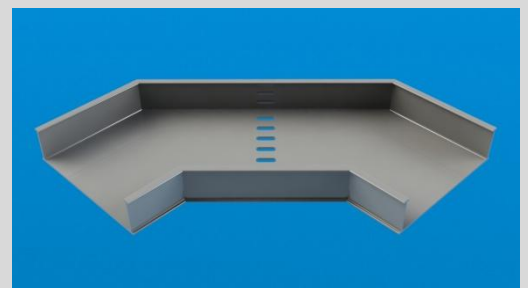

Cable Tray 45° Bend



Product	Width	Height	Kg/each
GRPEXTRSR90-50100	100mm	50mm	0.53
GRPEXTRSR90-50150	150mm	50mm	0.64
GRPEXTRSR90-50200	200mm	50mm	0.86
GRPEXTRSR90-50300	300mm	50mm	1.31
GRPEXTRSR90-80100	100mm	80mm	0.68
GRPEXTRSR90-80150	150mm	80mm	0.83
GRPEXTRSR90-80200	200mm	80mm	1.01
GRPEXTRSR90-80300	300mm	80mm	1.46

Product	Width	Height	Kg/each
GRPEXTRSR45-50100	100mm	50mm	0.53
GRPEXTRSR45-50150	150mm	50mm	0.64
GRPEXTRSR45-50200	200mm	50mm	0.86
GRPEXTRSR45-50300	300mm	50mm	1.31
GRPEXTRSR45-80100	100mm	80mm	0.68
GRPEXTRSR45-80150	150mm	80mm	0.83
GRPEXTRSR45-80200	200mm	80mm	1.01
GRPEXTRSR45-80300	300mm	80mm	1.46

Product	Width	Height	Kg/each
GRPINTRSR90-50100	100mm	50mm	0.53
GRPINTRSR90-50150	150mm	50mm	0.64
GRPINTRSR90-50200	200mm	50mm	0.86
GRPINTRSR90-50300	300mm	50mm	1.31
GRPINTRSR90-80100	100mm	80mm	0.68
GRPINTRSR90-80150	150mm	80mm	0.83
GRPINTRSR90-80200	200mm	80mm	1.01
GRPINTRSR90-80300	300mm	80mm	1.46

Product	Width	Height	Kg/each
GRPINTRSR45-50100	100mm	50mm	0.53
GRPINTRSR45-50150	150mm	50mm	0.64
GRPINTRSR45-50200	200mm	50mm	0.86
GRPINTRSR45-50300	300mm	50mm	1.31
GRPINTRSR45-80100	100mm	80mm	0.68
GRPINTRSR45-80150	150mm	80mm	0.83
GRPINTRSR45-80200	200mm	80mm	1.01
GRPINTRSR45-80300	300mm	80mm	1.46

External Risers



Internal Risers

Cable Tray 90° Int Riser

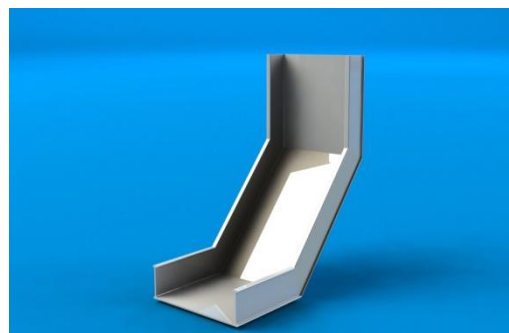

Cable Tray 45° Int Riser



T-Piece

Product	Width	Height	Kg/each
GRPEQT-50-100	100mm	50mm	0.53
GRPEQT-50-150	150mm	50mm	0.64
GRPEQT-50-200	200mm	50mm	0.86
GRPEQT-50-300	300mm	50mm	1.31
GRPEQT-80-100	100mm	80mm	0.68
GRPEQT-80-150	150mm	80mm	0.83
GRPEQT-80-200	200mm	80mm	1.01
GRPEQT-80-300	300mm	80mm	1.46



Product	Width	Height	Kg/each
GRPRED-50-100	100mm	50mm	0.53
GRPRED-50-150	150mm	50mm	0.64
GRPRED-50-200	200mm	50mm	0.86
GRPRED-50-300	300mm	50mm	1.31
GRPRED-80-100	100mm	80mm	0.68
GRPRED-80-150	150mm	80mm	0.83
GRPRED-80-200	200mm	80mm	1.01
GRPRED-80-300	300mm	80mm	1.46

Reducer



GRP Cable Troughs

150x110

Captrad Cable Ducting have been designed and manufactured with the user in mind, whilst offering excellent performance ease of use.

Captrad Cable Troughs can be supplied either as the Trough or with the uniquely designed 'Click-fit-Lid'. All our troughs are produced in 3mtr lengths and can easily be fabricated on/off site.

Advantages

Corrosion Resistant	Impact Resistant	Dimension Stability
Strong & Light weight	Click Fit Lid System	UV Stability
Non-Conductive	Easy to fabricate	Excellent working temps

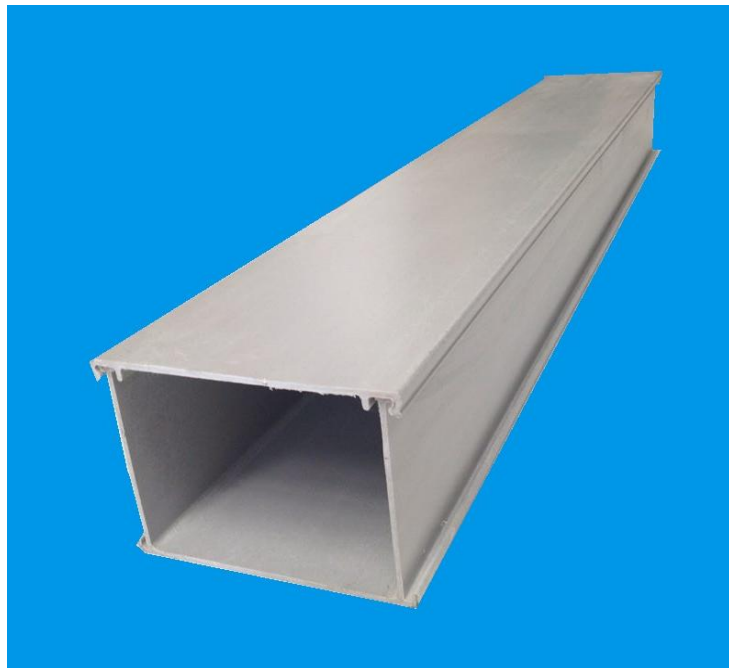

Specifications

The cable trays are manufactured glass by the pultrusion process from isophthalic polyester thermosetting resin reinforced with E glass giving a high strength dimensionally accurate and thermally stable product. The pultruded sections fully comply with all the requirements of EN13706, grade E17 – Specification of pultruded profiles.

The standard polyester resin is a halogen free fire retardant grade satisfying the requirements of BS476 Pt7, Class 2 and ASTM E84 25 sec - Surface spread of flame. Higher grade fire retardant products can be manufactured to order including the high fire resistance, low smoke and low toxicity required by the London Underground (LUL).

Cable Troughs can also be made to order in the highly corrosion resistant vinyl ester resin. GRP cable troughs are normally electrical non-conductive but for those applications with risk explosive atmospheres an anti-static version is available to order.

Our cable trays have been by Birse Rail at Liverpool Sandhills Lane NWR , Winwick Junction Winwick, Tamworth

Recycled Plastic Cable Troughs



The cable trenches have been developed for a number of customers but we found initial success supplying these products into Swedish Rail, where they were used to protect fibre optic communication cables, Deutsche Bahn and other European communication and rail companies.

Specifications

Each cable trough comprises the trough and a cover designed to fit into the trough. They are made from a mixture of recycled plastics primarily polyolefin's (polyethylene, polypropylene etc). These materials demonstrate good resistance performance to acids, alkalis, fuel oils, petrol, mineral oils and other common substances and offer good UV stability and weathering performance. They have high mechanical strength and have been used to protect HV, LV and communication cables against mechanical damage. They have been tested to various European Norm specifications. All troughs can be supplied with locks to prevent theft and when being laid are designed to interlock with the covers being installed in a manner to overlay the locked joints to add further protection to the cables. I have attached various images and a copy of the original flyer which details the bullet point benefits of these product

Product	Size	Production
Cable Trough	100x100x1mtr	150 units per day
Lid	100x1mtr	
Cable Trough	130x130x1mtr	
Lid	130x1mtr	
Cable Trough	200x130x1mtr	
Lid	200 x 1mtr	

- Lightweight no cranes**
- Modular self aligning with secure lids**
- Fire Rated Zero**
- 100% Recycled**
- 100% recyclable**
- Impact resistant at -40°C**
- 40 Tonne dynamic load capacity**
- Max width 500mm**

GRP Cable Ladders

GRP Cable Trays at a glance		
	Standard	Alternative
Material	ISO Polyester Resin	
Fire Rating	Class 2 Fire Rated	Modar
Length	3000mm	6000mm
Width	150mm – 1000mm	
Height	100mm	150mm
Fittings	All Stainless Steel	



GRP Cable Ladders are supplied from stock in a range of standard sizes which allows them to accommodate almost all projects. Our ladders systems are designed to utilize space and to give cable protection. The design of the side profile combines great strength with light weight. All of Captrad Cable Systems ladders have been designed to improve load-bearing capabilities. We are able to produce GRP Cable Ladders to a variety of sizes and special resin systems to match any working environment. We can also supply cable ladders dividers and lids if required. There are many advantages to using our GRP Cable Ladders:

- Light weight and easy to use
- Excellent UV stability and fire properties
- Various sizes available in the ladder profile
- Available in various resin systems offering excellent corrosion resistance
- Ladders are produced to NEMA standards
- Excellent strength properties under high loads

Cable Ladders

Product	Width	Height	Kg/mtr
GRPLDR-100-300/3	300mm	100mm	2.92
GRPLDR-100-450/3	450mm	100mm	3.21
GRPLDR-100-600/3	600mm	100mm	3.50
GRPLDR-100-700/3	700mm	100mm	3.68
GRPLDR-150-300/3	300mm	150mm	3.62
GRPLDR-150-450/3	450mm	150mm	3.91
GRPLDR-150-600/3	600mm	150mm	4.20
GRPLDR-150-700/3	700mm	150mm	4.38



Product	Width	Height	Kg/each
GRPLDR-90EB -100-300	300mm	100mm	3.02
GRPLDR-90EB-100-450	450mm	100mm	3.68
GRPLDR-90EB-100-600	600mm	100mm	4.35
GRPLDR-90EB-100-700	700mm	100mm	4.90
GRPLDR-90EB-150-300	300mm	150mm	3.72
GRPLDR-90EB-150-450	450mm	150mm	4.46
GRPLDR-90EB-150-600	600mm	150mm	5.24
GRPLDR-90EB-150-700	700mm	150mm	5.83

Bends

Cable Ladder Flat Elbow 90

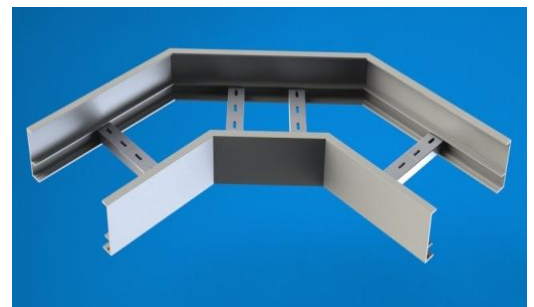

Product	Width	Height	Kg/each
GRPLDR-45EB-100-300	300mm	100mm	2.14
GRPLDR-45EB-100-450	450mm	100mm	2.44
GRPLDR-45EB-100-600	600mm	100mm	2.93
GRPLDR-45EB-100-700	700mm	100mm	3.13
GRPLDR-45EB-150-300	300mm	150mm	2.62
GRPLDR-45EB-150-450	450mm	150mm	2.93
GRPLDR-45EB-150-600	600mm	150mm	3.49
GRPLDR-45EB-150-700	700mm	150mm	3.84

Cable Ladder Flat Elbow 45



Internal Risers

Product	Width	Height	Kg/each
GRPLDR-90INTR-100-300	300mm	100mm	2.18
GRPLDR-90INTR-100-450	450mm	100mm	2.44
GRPLDR-90INTR-100-600	600mm	100mm	2.70
GRPLDR-90INTR-100-700	700mm	100mm	2.86
GRPLDR-90INTR-150-300	300mm	150mm	2.68
GRPLDR-90INTR-150-450	450mm	150mm	2.94
GRPLDR-90INTR-150-600	600mm	150mm	3.20
GRPLDR-90INTR-150-700	700mm	150mm	3.35

Product	Width	Height	Kg/each
GRPLDR45INTR-100-300	300mm	100mm	2.00
GRPLDR45INTR-100-450	450mm	100mm	2.26
GRPLDR45INTR-100-600	600mm	100mm	2.52
GRPLDR45INTR-100-700	700mm	100mm	2.68
GRPLDR45INTR-150-300	300mm	150mm	2.48
GRPLDR45INTR-150-450	450mm	150mm	2.74
GRPLDR45INTR-150-600	600mm	150mm	3.00
GRPLDR45INTR-150-700	700mm	150mm	3.15

Product	Width	Height	Kg/each
GRPLDR-TP-100-300	300mm	100mm	3.92
GRPLDR-TP-100-450	450mm	100mm	4.26
GRPLDR-TP-100-600	600mm	100mm	4.26
GRPLDR-TP-100-700	700mm	100mm	7.12
GRPLDR-TP-150-300	300mm	150mm	4.88
GRPLDR-TP-150-450	450mm	150mm	5.22
GRPLDR-TP-150-600	600mm	150mm	8.08
GRPLDR-TP-150-700	700mm	150mm	8.48

Cable Ladder Int Riser 90



Cable Ladder Int Riser 45

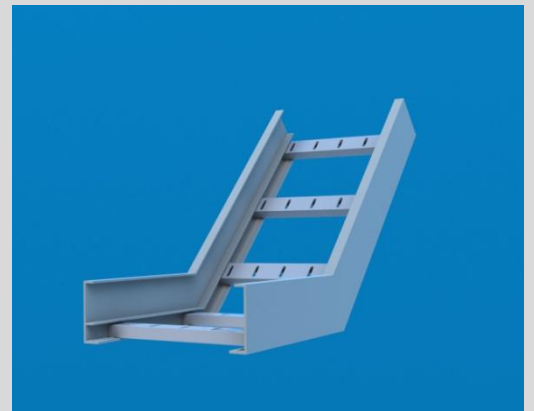

T - Piece

Cable Ladder T-Piece



GRP Uni Strut Profiles

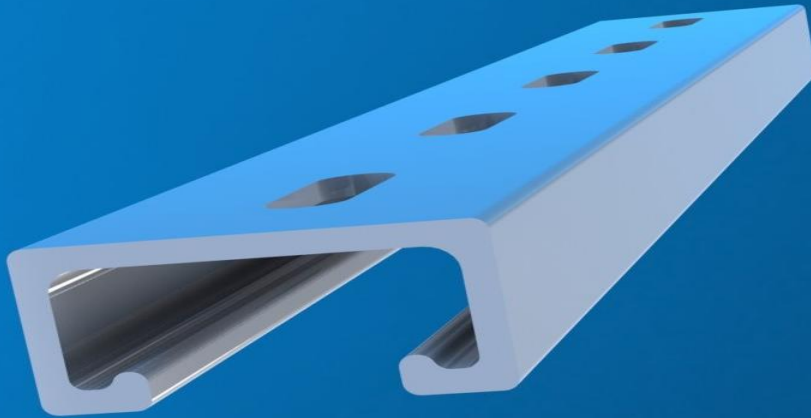

GRP Uni-Strut type profile

Product description

The 41x41x3.2mm mm grp uni-strut profile is made by the pultrusion process giving a section that is structurally strong and dimensionally consistent . The uni-strut profile matches the steel strut so that it takes the same shaped nuts, with and without springs that are widely available for the steel strut.

The profile meets all the requirements of EN 13706 – Specification of grp profiles – Grade E17 and is manufactured under ISO 9000 registered quality control system.

The profile is stocked in 6m lengths, colour grey.

We also have the half strut available at 41mm x 25mm x 3mm

Applications

The strut profile is electrically non-conductive and resistant to corrosion by water, salt and most chemicals.

Typical applications include:

Support frames for cabinets holding electrical switchgear, process control instruments, etc

Support for electrical cable trays and ladders

Support for pipes, conduits, etc

Mechanical Properties

Full section modulus =19GPa measured by the method- EN 13706, Annex D

Moment of inertia Ixx = 130,000mm⁴

Bolt pull out strength with Zebidee nut - 2000N

Concentrated Load at centre of span. Deflection limited to span/200

	Span mm			
	1000	1500	2000	2500
Load kg	150	65	38	25

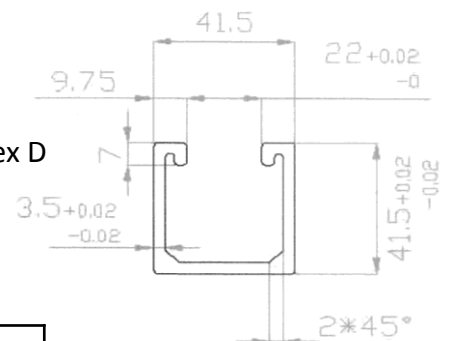

Captrad Cable Systems

A Division of Captrad Ltd
19 Hewitt Business Park
Winstanley Road
Orrell
Wigan
WN5 7XB
ENGLAND

Tel: +44 (0)1695 680010

Fax: +44 (0)1695 680009

sales@captradcablesystems.co.uk

www.captradcablesystems.co.uk

www.captrad.com

